

LINE	BBQ LINE
MODEL	SINK W/ SOAP DISPENSER
NUM	

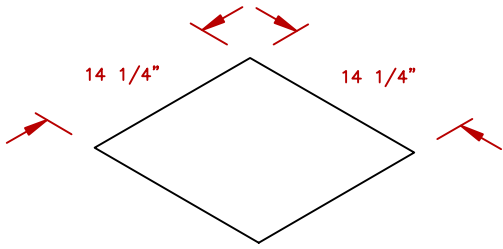
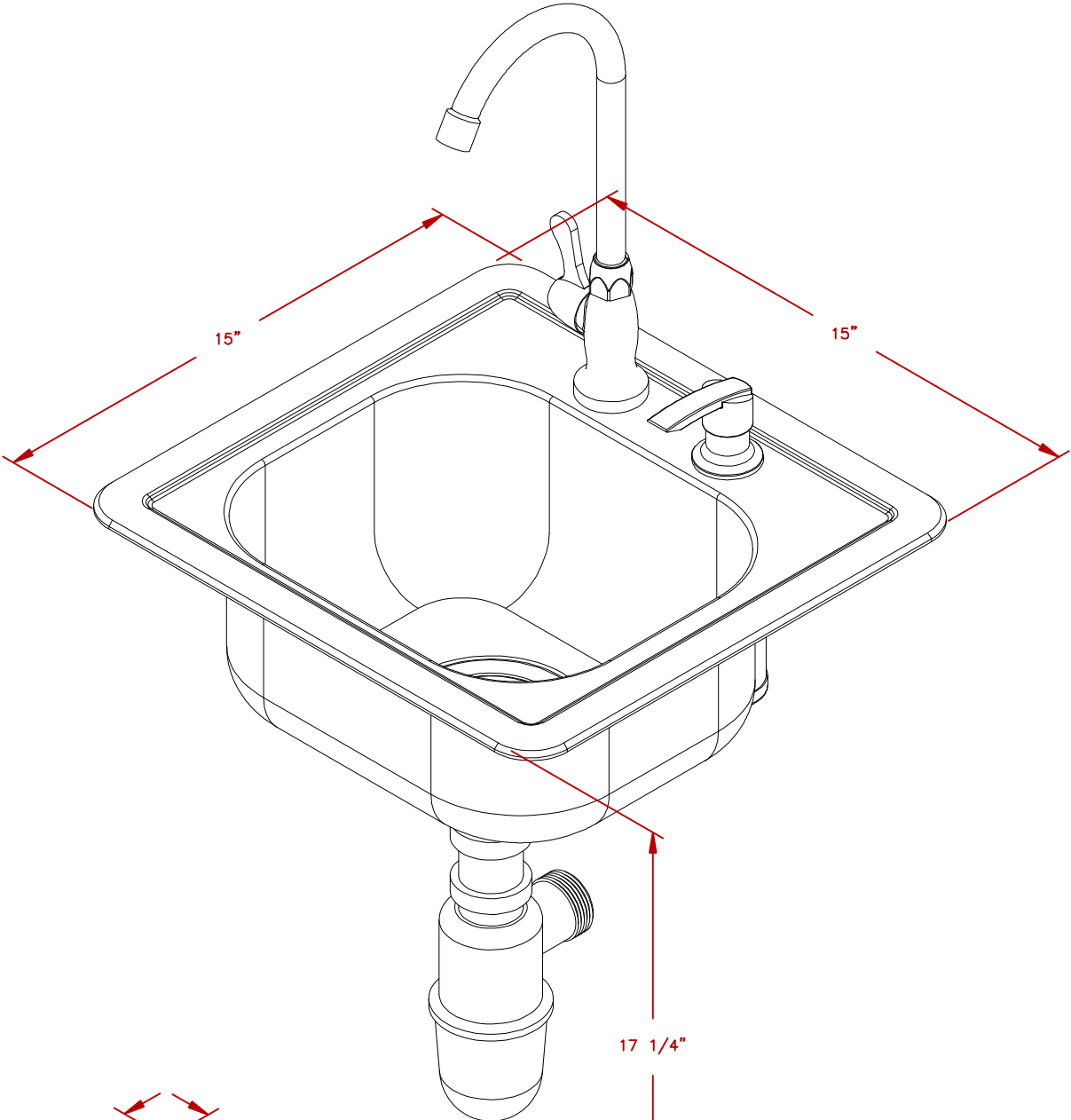

CUT-OUT DIMENSIONS

NOTE:  
ONE FAUCET INLET ONLY

NOTE:  
DUE TO OUR CONTINUOUS IMPROVEMENT PROGRAM, ALL MODELS  
AND SPECIFICATIONS ARE SUBJECT TO CHANGE WITHOUT NOTICE.

	TITLE	
	2018 BARBECUE LINE ACCESSORIES-DROP IN- SINK W/ SOAP DISPENSER	
SCALE:	DWG NO.	DWG BY
	BBQ11963	J.ORNELAS
REVISED	REV. DESCR.	DATE
		12/01/17